

## KP-60C 清水泵 CLEAN WATER PUMP

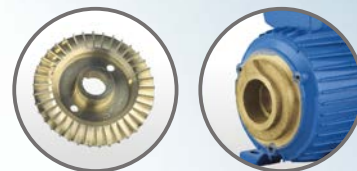

### CONSTRUCTION

#### PUMP: Peripheral

Pump Body: Cast Iron

Impeller: Brass

Mechanical Seal: Carbon + Ceramic + Stainless steel + Rubber

Front cover: Aluminum With Full Brass Insert

#### MOTOR: Single Phase Heavy Duty Continuous Work

Motor Housing with Front Cover: Aluminium with Brass

Shaft: Carbon Steel / 304 Stainless Steel Welded

/ 420 Stainless Steel

Insulation: Class B / Class F

Protection: IP44 / IP54

Cooling: External ventilation

### 结构特征

泵: 旋涡式清水泵

泵体: 铸铁

叶轮: 铜

机械密封: 石墨+陶瓷+不锈钢+橡胶

前盖: 镶全铜盖(机壳一体)

电机: 单相大马力连续工作制

电机机座: 铝压铸

转轴: 45#碳钢/304不锈钢焊接轴/整轴420不锈钢

绝缘等级: B级/F级

防护等级: IP44/IP54

冷却方式: 风冷



KP-60C  
(NB-500)

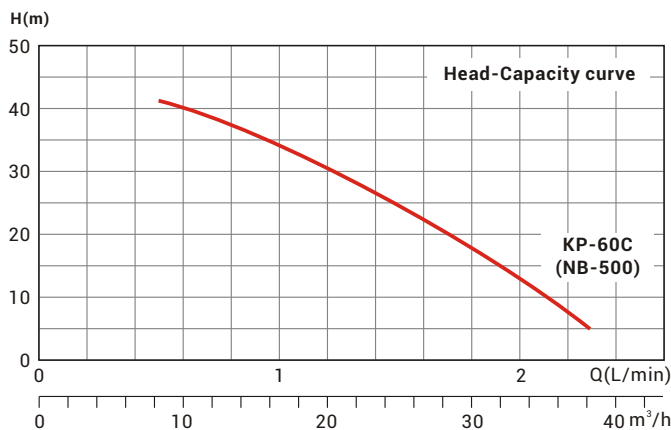

### 包装尺寸及毛重

#### PACKAGE DIMENSIONS & G.W.

型号 Model	长 L	宽 W	高 H	重量 KG	1X20"柜数量 1X20"FCU QTY (pcs)
KP-60C (NB-500)	250	165	210	5.4	3200

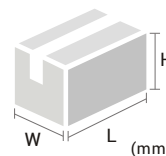

安装尺寸图请查看55页。

For installation dimensions, please refer to page 55.

### 技术参数 PERFORMANCE SPECIFICATIONS

型号 Model	功率 Power		电流 Ampere (A)	最大吸程 Suct.max (m)	进出口管径 Inlet/Outlet DIA	流量 Q=capacity								
						m³/h	0.48	0.6	0.75	0.96	1.2	1.5	1.89	2.3
KP-60C (NB-500)	HP	kW	220V/50Hz	9	1"x1"	l/min	8	10	12.5	16	20	25	31.5	38
						扬程 H (m)	41	38.5	35.5	31	25.5	19	11	3

\*110V,110/220V/60Hz etc. Models are available on request.

## 清水泵系列 CLEAN WATER PUMP SERIES

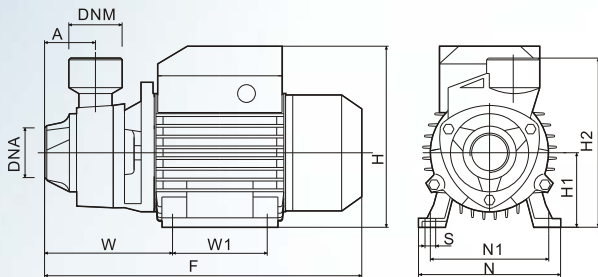

KP, IDB, KFP0, KRP, KP-60C Series

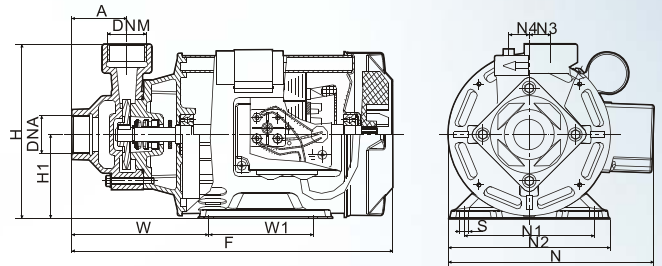

CP-130 Series

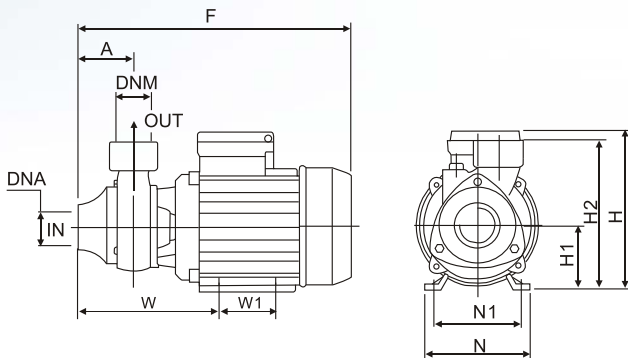

KPM Series

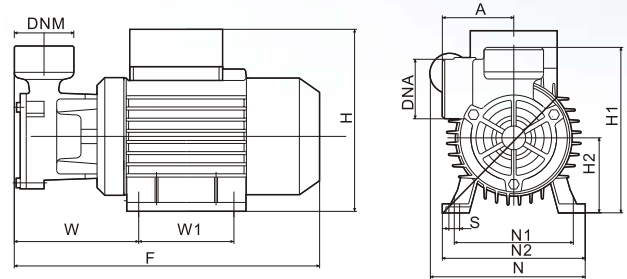

KDB, KFP1 Series

### 安装尺寸 INSTALLATION DIMENSIONS

型号 Model	尺寸 DIMENSIONS (mm)												
	A	F	H	H1	H2	N	N1	N2	N3	N4	W	W1	S
1KP-60	45	265	152	63	138	118	100	-	-	-	110	80	10
1KP-70	50	305	181	71	156	136	112	-	-	-	122	90	10
1KP-80	50	305	181	71	156	136	112	-	-	-	122	90	10
1.5KP-90	68	380	182	80	175	180	162	-	-	-	138	100	10
IDB-35	50	268	155	63	143	142	100	-	-	-	115	80	10
IDB-40	55	305	176	71	152	155	112	-	-	-	120	90	10
IDB-50	55	305	176	71	152	155	112	-	-	-	120	90	10
IDB-60	68	380	182	80	156	180	130	-	-	-	138	100	10
CP130(PM16)	47.5	277	150	72	-	178	112	139	20	18	118	90	8
KPM-45	50	265	155	63	143	120	97	-	-	-	67	80	10
KPM-60	50	290	172	71	156	135	112	-	-	-	71.5	90	10
KPM-80	50	290	172	71	156	135	112	-	-	-	71.5	90	10
KDB-125A	60	256	154	143	63	118	110	118	-	-	-	101	10
KDB-330A	60	256	154	143	63	118	110	118	-	-	-	101	10
KDB-550A	72	305	176	176	71	136	112	136	-	-	-	122	10
KDB-750A	72	305	176	176	71	136	112	136	-	-	-	122	10
KFP0	35	215	166	63	143	120	100	-	-	-	60	80	7
KFP1	23	225	166	109	143	120	100	-	-	-	68	80	7
KRP-16M	42	247	158	63	138	132	65	-	-	-	64	-	8
KP-60C	22.5	198	158	63	153	122	100	-	-	-	40.5	80	7